

WALL EXHAUST FAN



WFM-250

10" Wall Exhaust Fan



Application



Vol. / Freq 220-240V/50-60Hz
Power 36W

Packaging Size 79.2*36.4*37.4
Cut-Out Size 26-35m²
Qty Per Ctn 6

WORLD CLASS FEATURES

- Powerful Performance [High air delivery]
- Synergetic Aesthetics [Available in a range of designer shades]
- Rust-free Fan [Made of special grade plastic]
- Great value for money [Unparalleled cost v/s value in it's class]
- Ideal for kitchens and bathrooms



Product Size

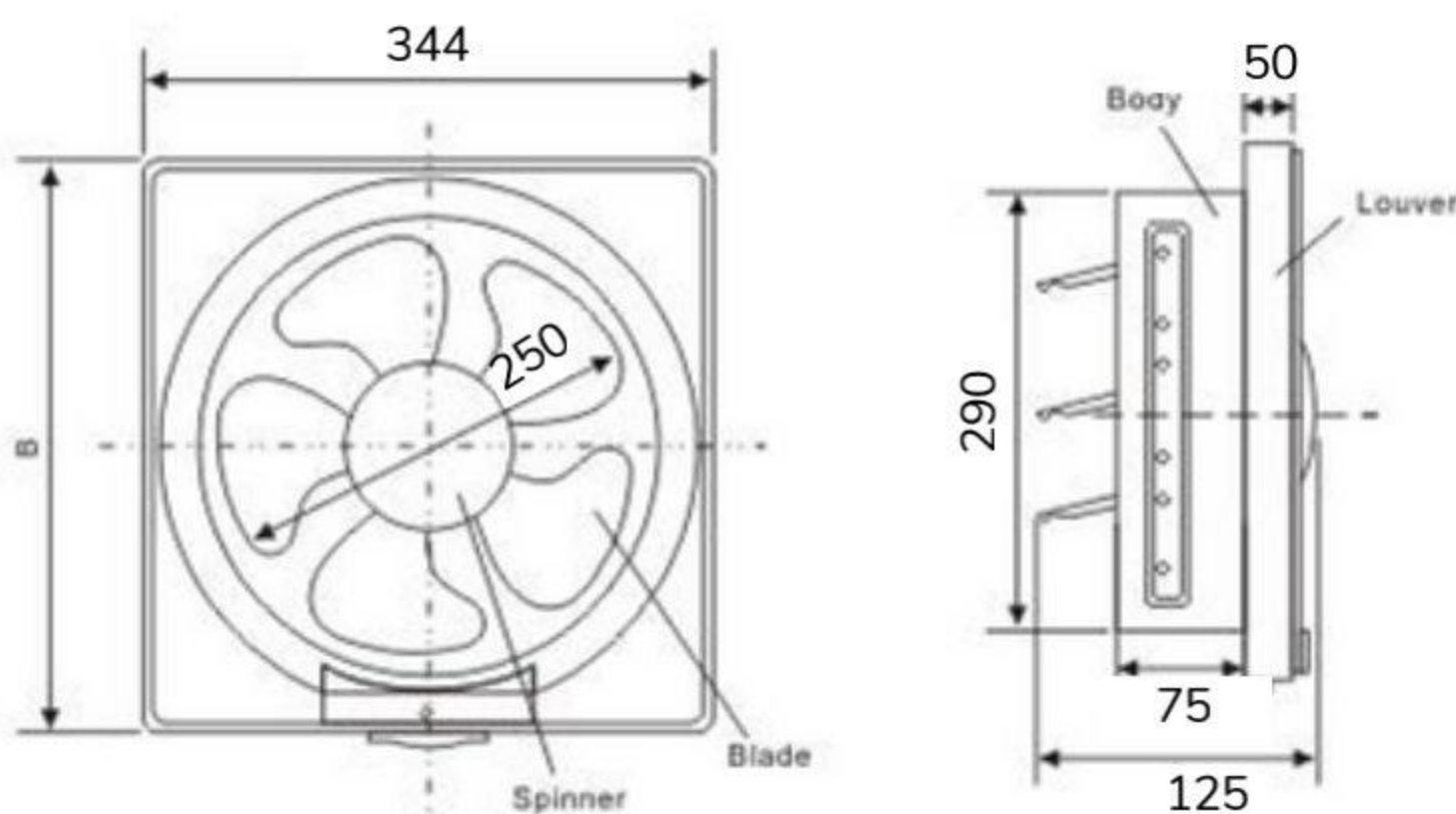

Fans are the perfect accessories to enhance your interiors and complement your lifestyle.

- ✓ Elegant Design
- ✓ Modern Technology
- ✓ High Pressure & Low Noise
- ✓ Silicon Steel Motor
- ✓ 100% Pure Cooper Winding